

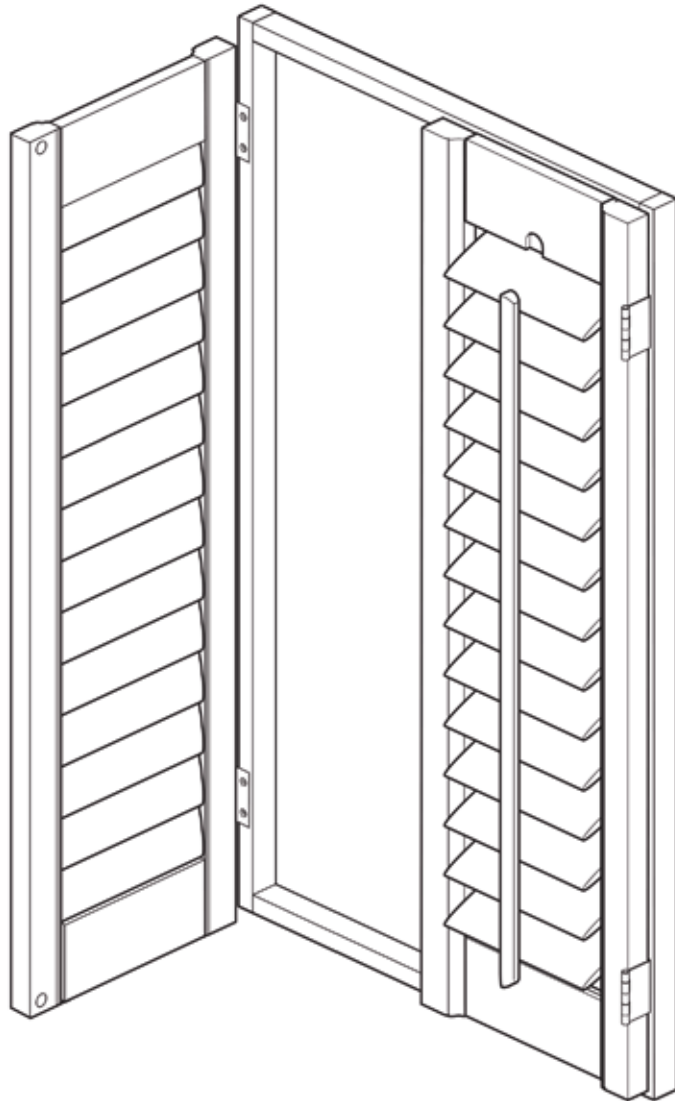

# MEASURING INSTRUCTIONS



The New England Shutter Company

16 Jaggard Way London SW12 8SG

Tel: +44 (0)20 8675 1099

[enquiries@tnesc.co.uk](mailto:enquiries@tnesc.co.uk)

[www.thenewenglandshuttercompany.com](http://www.thenewenglandshuttercompany.com)

# CHOOSE YOUR STYLE



Tick box

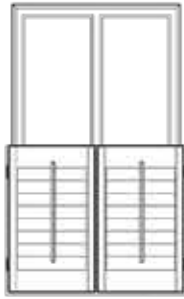

Tick box

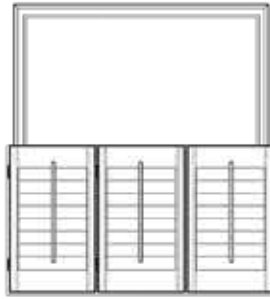

Tick box

Café style

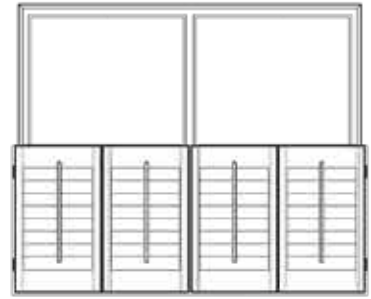

Tick box

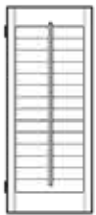

Tick box



Tick box

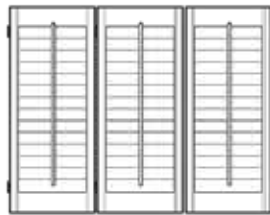

Tick box

Full height

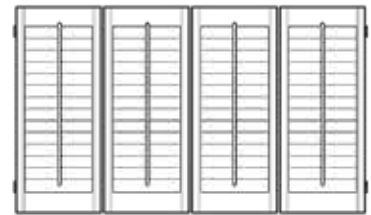

Tick box



Tick box



Tick box

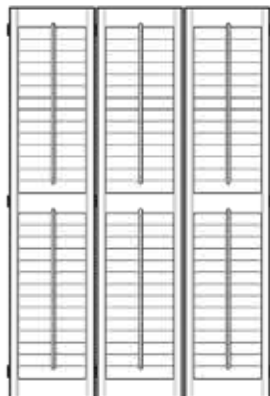

Tick box

Full height with mid rail

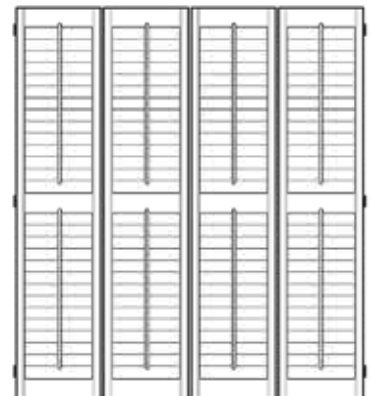

Tick box



Tick box



Tick box

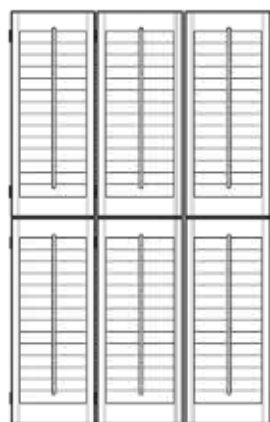

Tick box

Tier on Tier

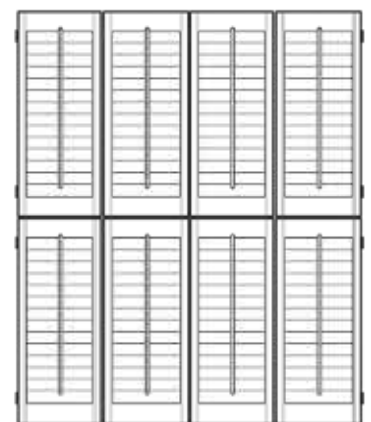

Tick box

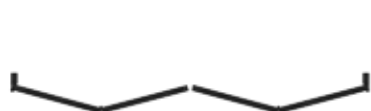
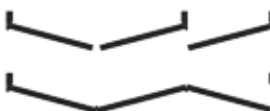
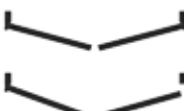

The configuration of hanging can vary as illustrated

# CHOOSE YOUR BLADE SIZE

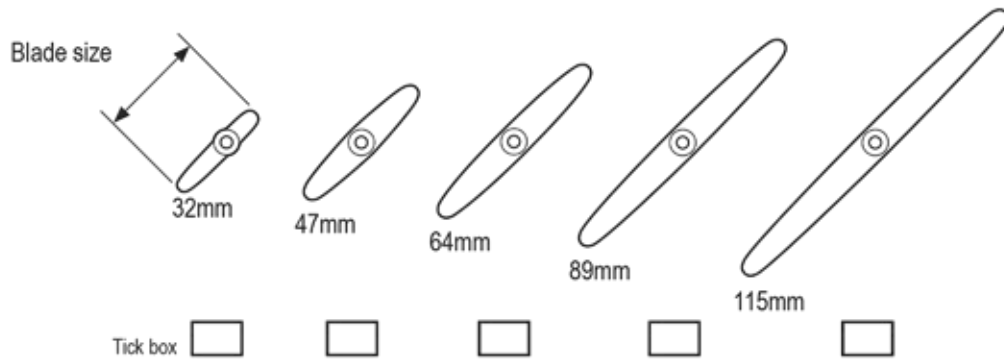

# CHOOSE YOUR FRAME FIXING 1, 2 OR 3

1 Tick box

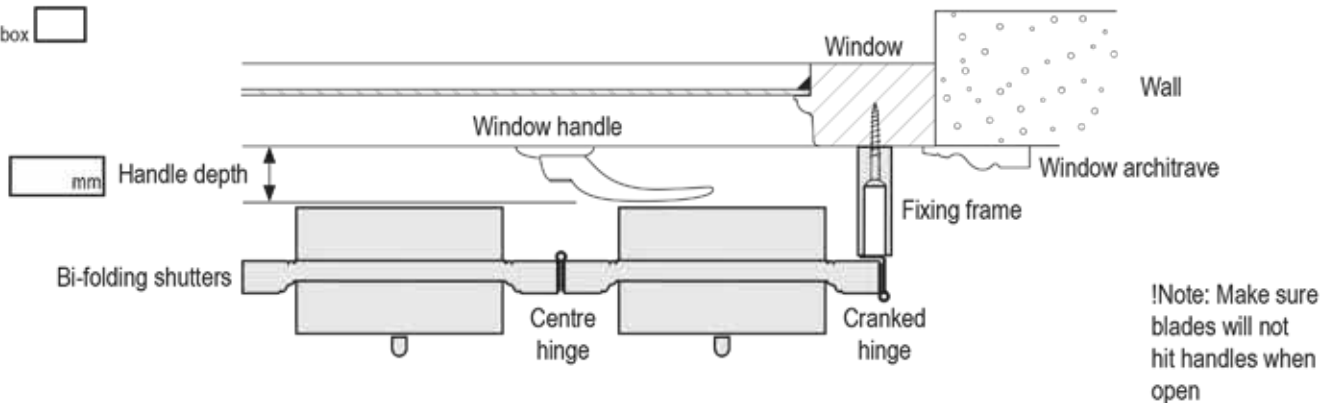

**1. Frame fixed to window**

2 Tick box

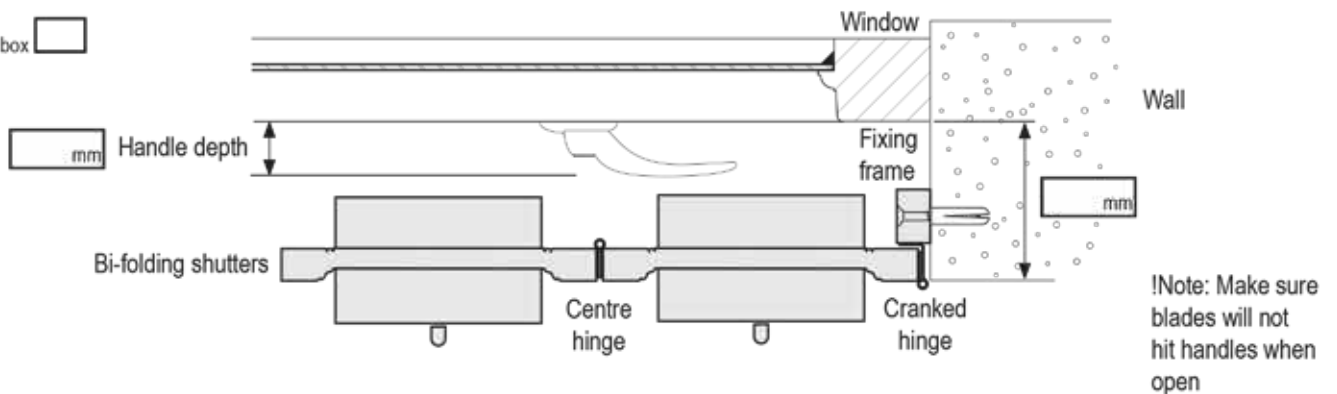

**2. Frame fixed to inside of recess**

3 Tick box

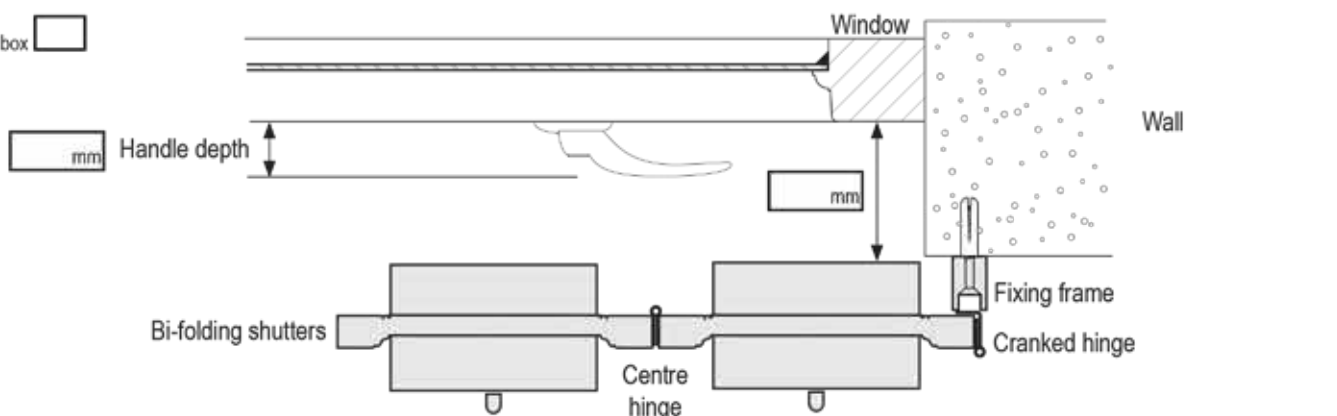

**3. Frame fixed to outside of recess**

# MEASURING YOUR WINDOW

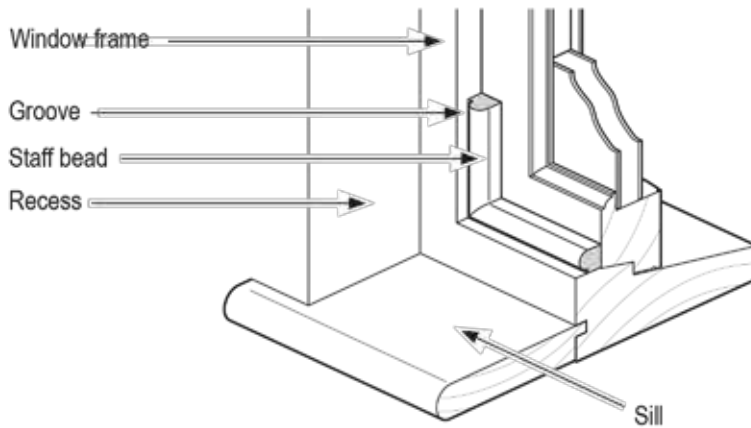

For shutter frames against the window frame measure from the groove between staff bead and window frame.

Please let us know these measurements. We will then work out the shutter sizes you require along with the frame. Please also let us know the paint colour or wood type, and hinge finish you would like.

**!Note:** Check to see if handles or locks protrude forward of the staff bead and note by how much

**Option 1. Frame fixed to window.**  
Frame can sit against the window. This leaves the sill free to be used

**Option 2. Frame fixed to inside of recess.**  
Shutters can fold back onto walls

**Option 3. Frame fixed to outside of recess.**  
Shutters can fold back onto walls

**Option 1, 2, & 3 if relevant**  
Measure from top of sill to top of Meeting Rail



Measurements mm

**Option 1**  
Measure from groove between each staff bead and window frame



Measurements mm

**Option 1**  
Measure from top of sill to to groove of staff bead.

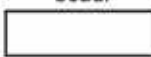

Measurements mm

**Option 2 or 3**  
For a recess window measure from top of sill to underside of recess



Measurements mm

**Option 2 or 3**  
Measure width of recess (inside to inside)

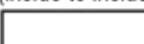

Measurements mm

